



CARTABLE

cartable

cartable



CAHIER

cahier

cahier

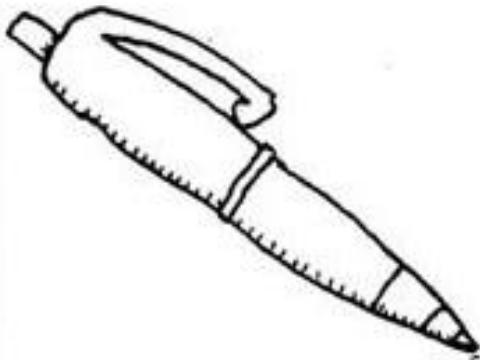

STYLO

stylo

stylo

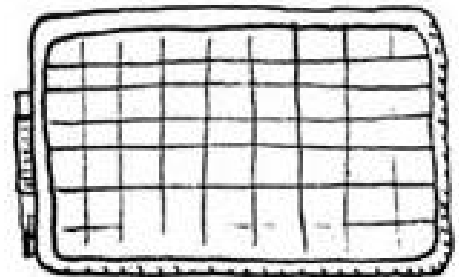

ARDOISE

ardoise

ardoise

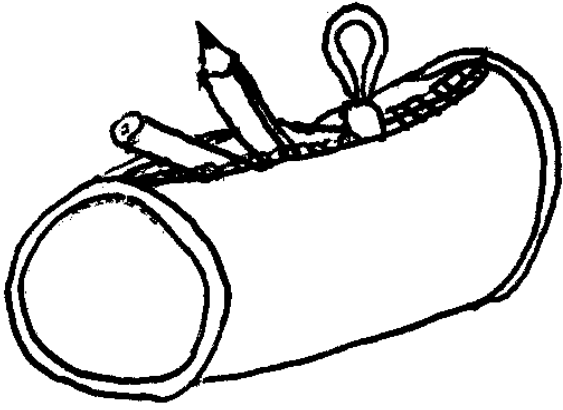

TROUSSE
trousse
trousse



GOMME
gomme
gomme

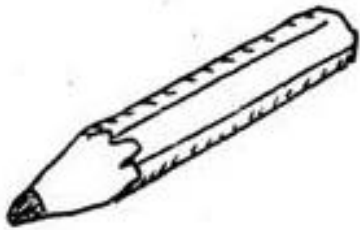

CRAYON
crayon
crayon



LIVRE
livre
livre

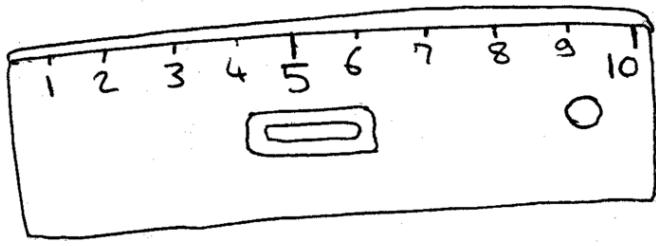

RÈGLE

règle

règle

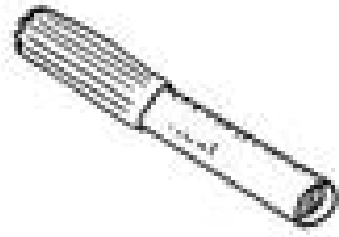

FEUTRE

feutre

feutre

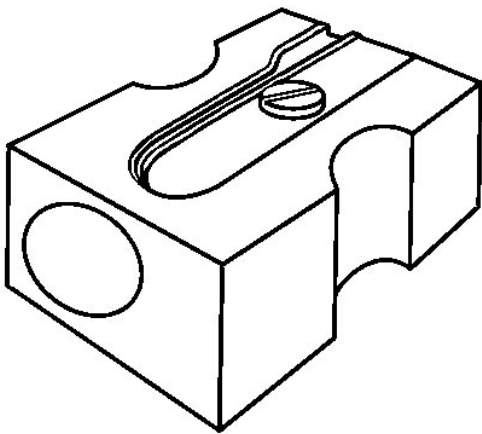

TAILLE CRAYON

taille crayon

taille crayon



PEINTURE

peinture

peinture



POT
pot
pot



PINCEAU
pinceau
pinceau



CRAIE
craie
craie



ENCRE
encre
encre



COLLE
colle
colle



JEU
jeu
jeu



PION
pion
pion



DÉ
dé
dé

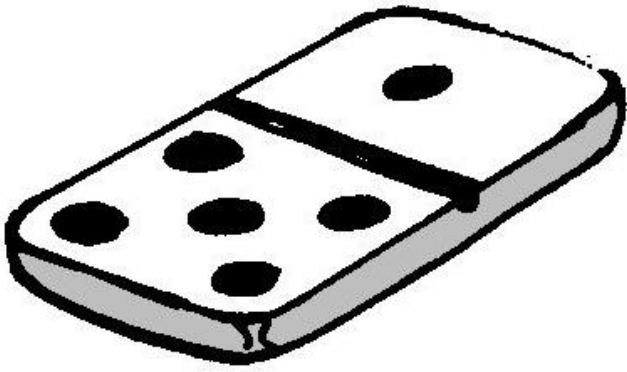

DOMINO

domino

domino



PUZZLE

puzzle

puzzle

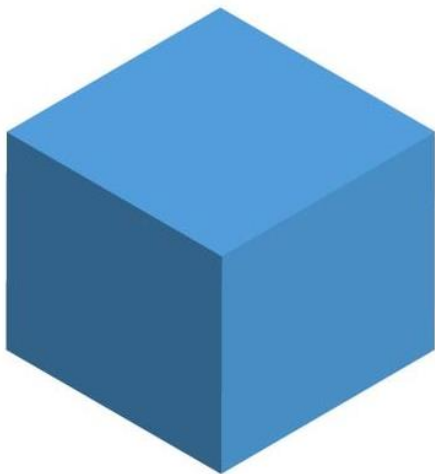

CUBE

cube

cube



PERLE

perle

perle

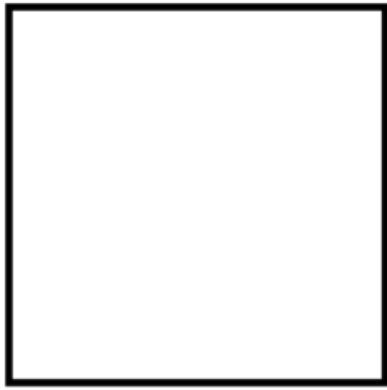

CARRÉ

carré

carré

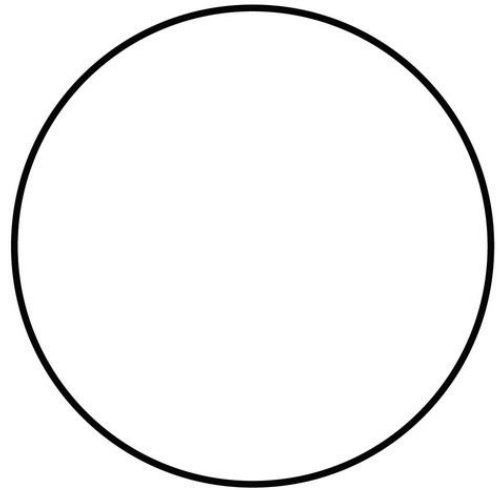

ROND

rond

rond



RECTANGLE

rectangle

rectangle

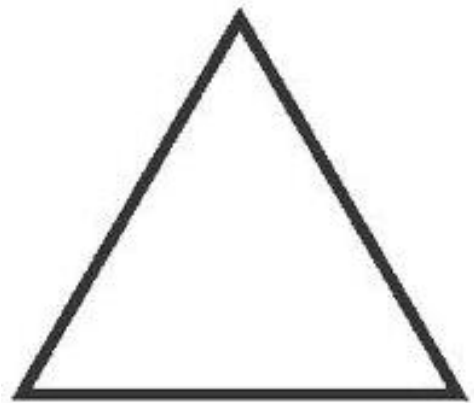

TRIANGLE

triangle

triangle

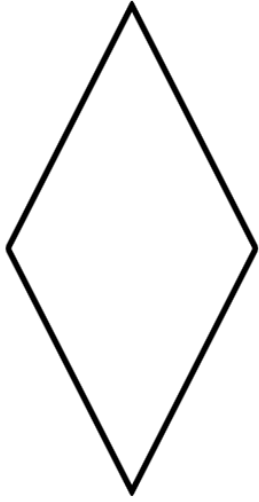

LOSANGE

losange

losange

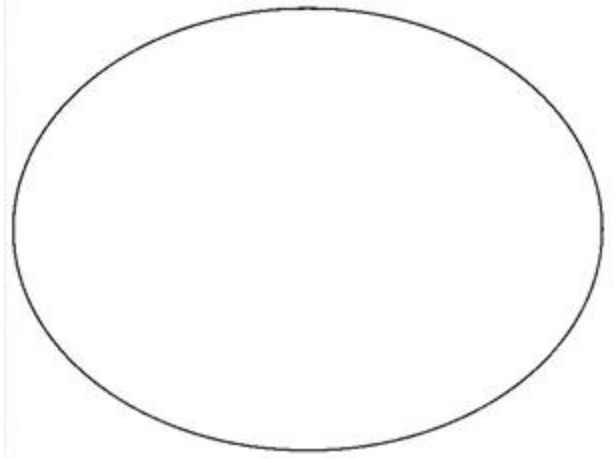

OVALE

ovale

ovale



CARTES

cartes

cartes

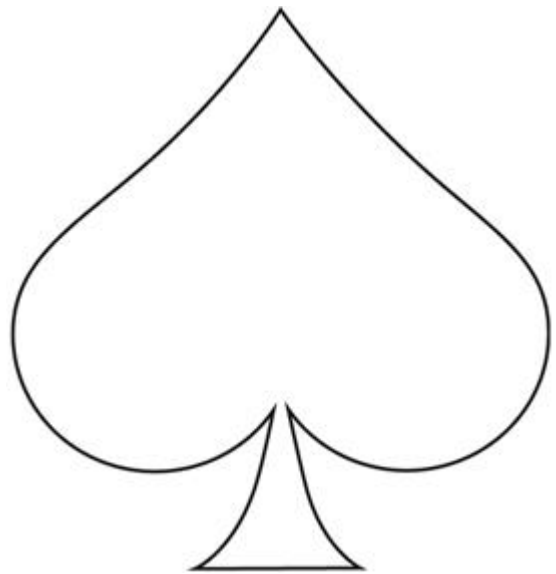

PIQUE

pique

pique

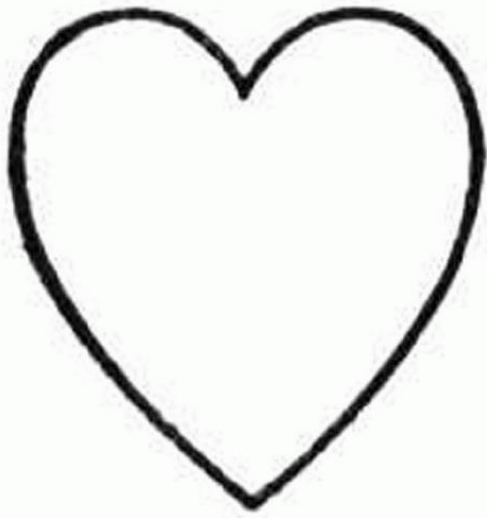

CŒUR

cœur

cœur

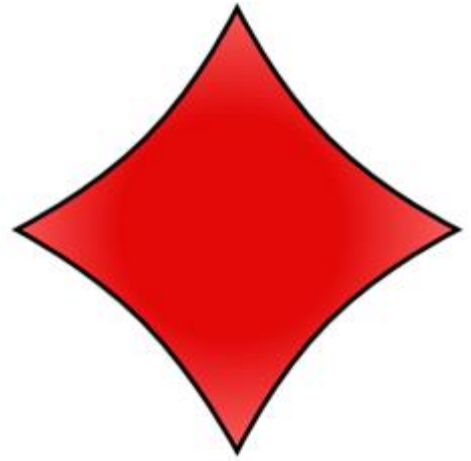

CARREAU

carreau

carreau

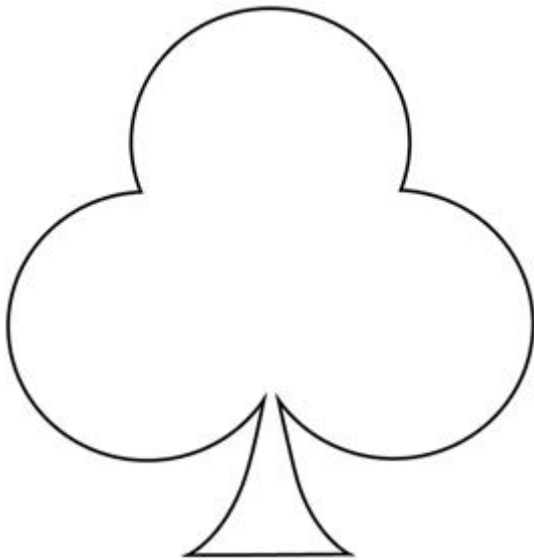

TRÈFLE

trèfle

trèfle



TÉLÉPHONE

téléphone

téléphone

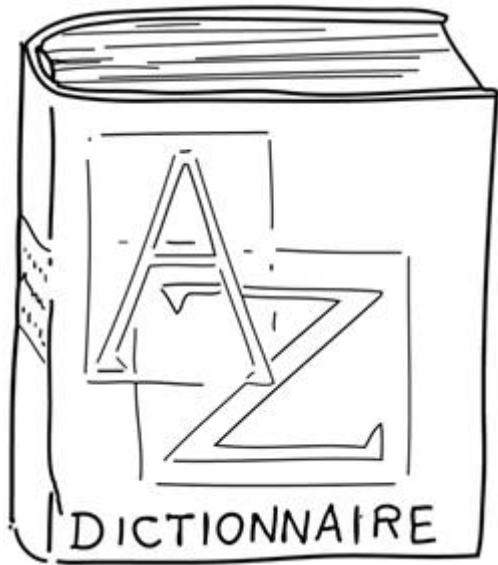

DICTIONNAIRE
dictionnaire
dictionnaire



CHANSON
chanson
chanson



POÉSIE
poésie
poésie



LETTRE
lettre
lettre

ABCDE

FGHIJK

LMNOP

QRSTU

VWXYZ

ALPHABET

alphabet

alphabet



MOINS

moins

moins



PLUS

plus

plus



FOIS

fois

fois

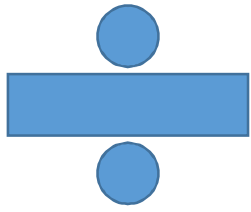

DIVISER

diviser

diviser